

Article number: 20476663

Description: E+G Tommy screw with movable bar
DIN 6306M 10-40-E

Measures

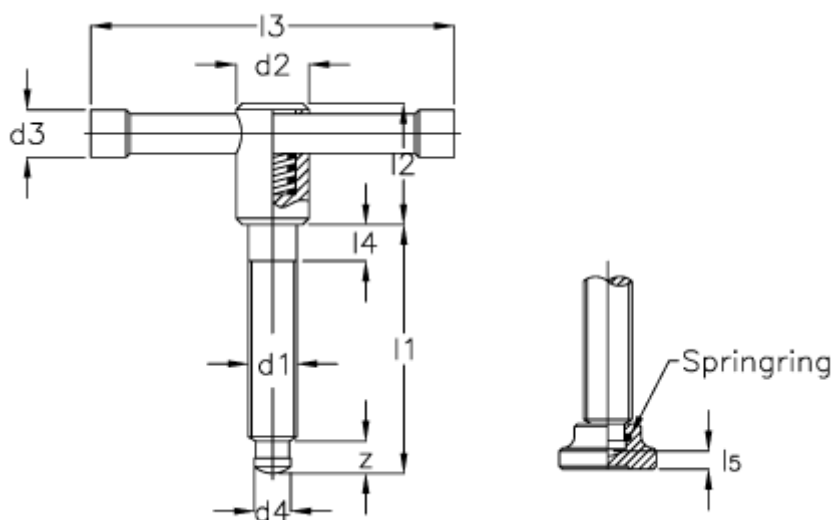

d1	= M 10	l5 = 3.6
d2	= 18	z = 8.2
d3	= 8	
d4 h11	= 8.0	
l1	= 40	
l2	= 32	
l3	= 80	
l4	= 10	